

# Data Sheet



Article number: 339707440000

Description: Multibeam 6 Coupling 707.44.0000  
Aluminium relieved & clamp hubs

## Measures

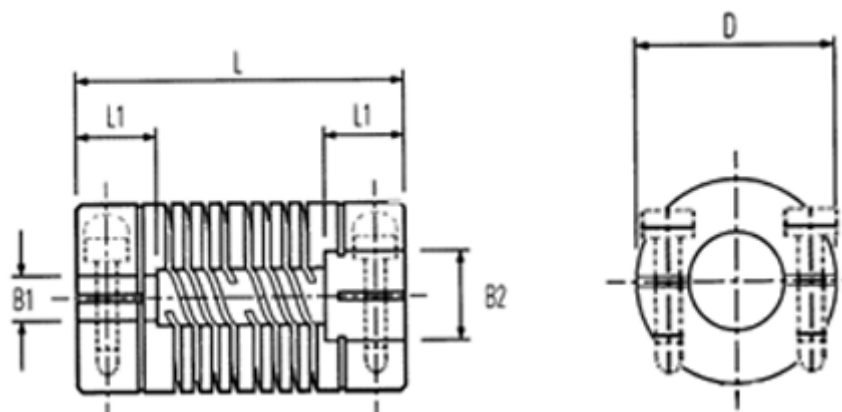

B2: Pre-drilled	= 9.0	Max parallel displacement = 7
B2: Pre-drilled	= 14.00	Peak Torque NM = 30.00
Cap screw	= M5	
D	= 44.5	
L	= 76.2	
L1	= 20.0	
Max angular displacement	= 0.80	
Max B1 & B2	= 22.00	